

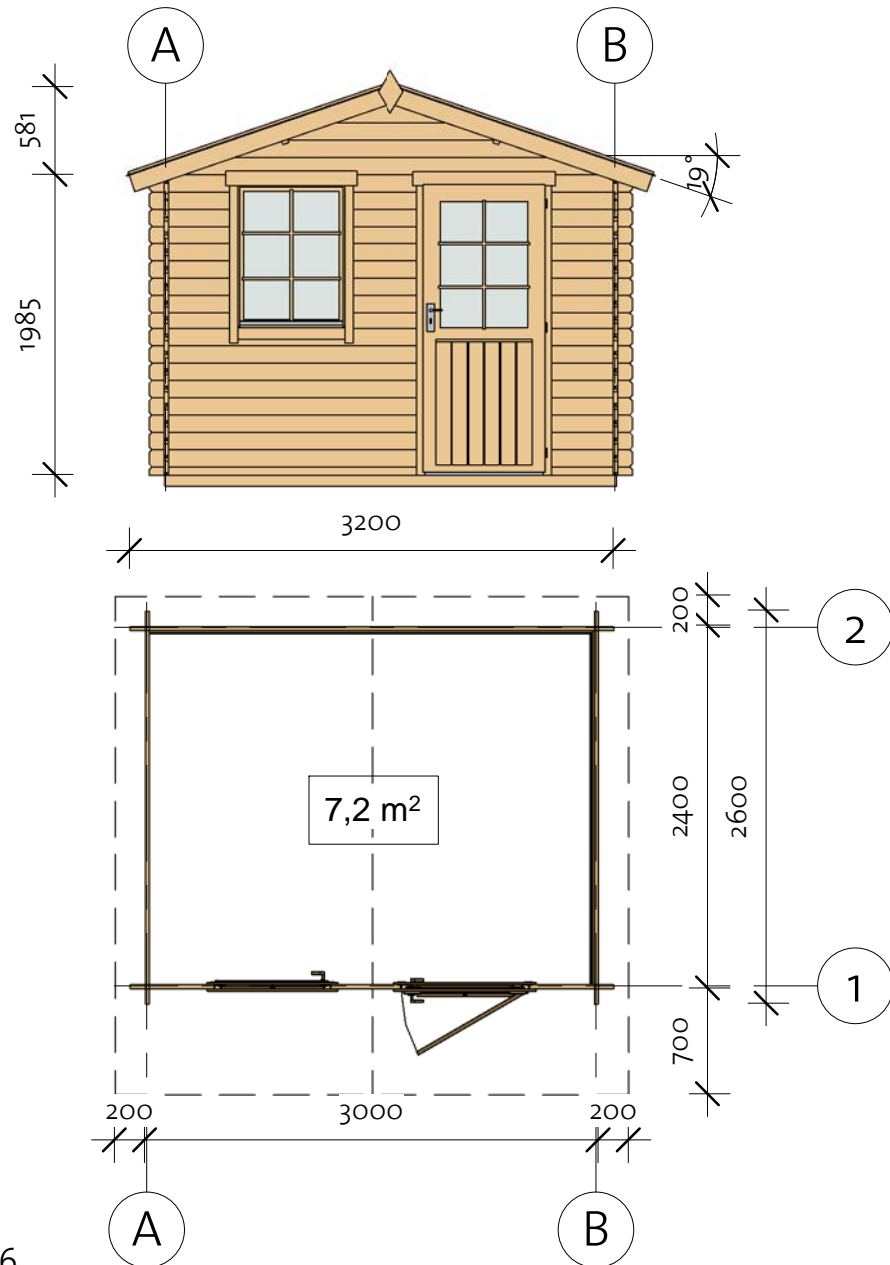

HB 3024 ET-EF 28 (3000x2400)



HB 3024 ET-EF 28 (300X240)

Foundation

Impregnated foundation beams				
Mark	Type	Profile	Count	Length

IFB	IFB 40X70		5	2990
-----	--------------	---	---	------

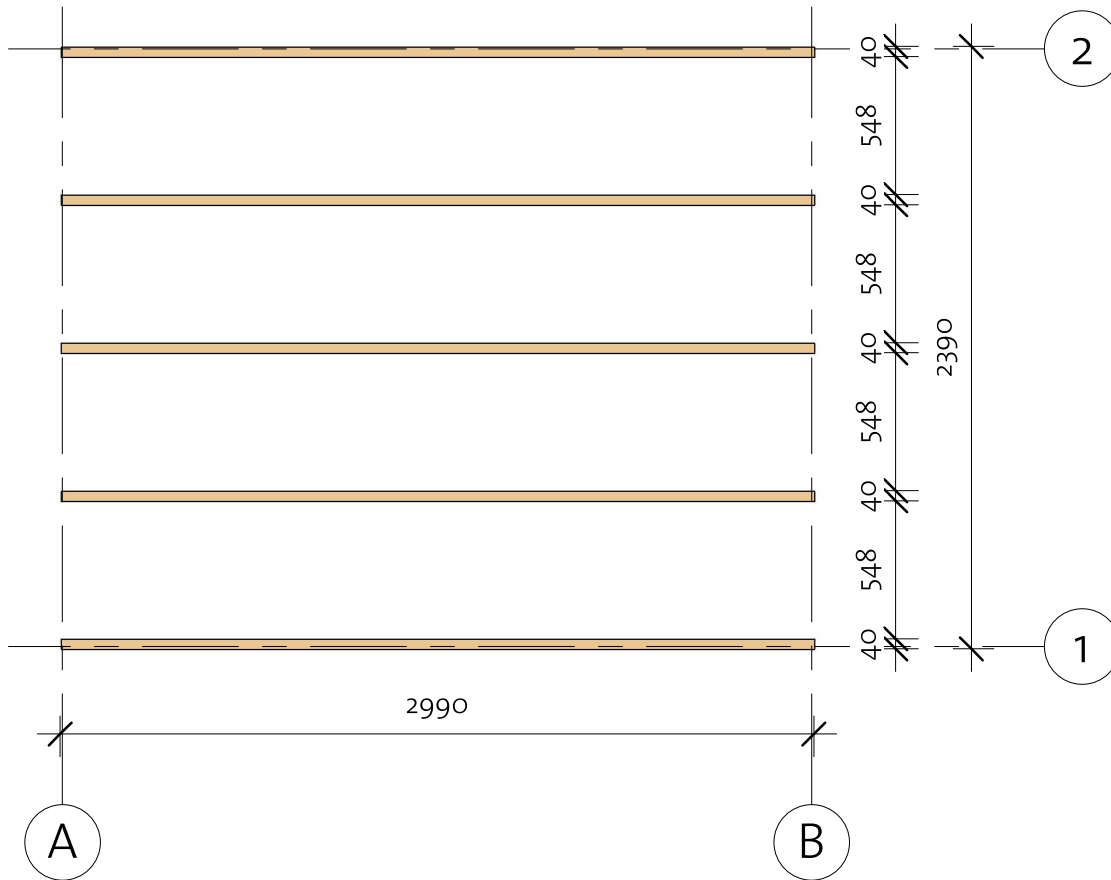



HB 3024 ET-EF 28 (300X240)

Floor Plan

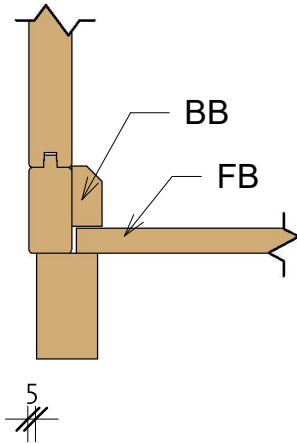
① Baseboard



Floor Schedule				
Mark	Type	Profile	Count	Length
FB	FB 17x114		27	2338
BB1	BB 20x40		2	3000
BB2	BB 20x40		2	2400

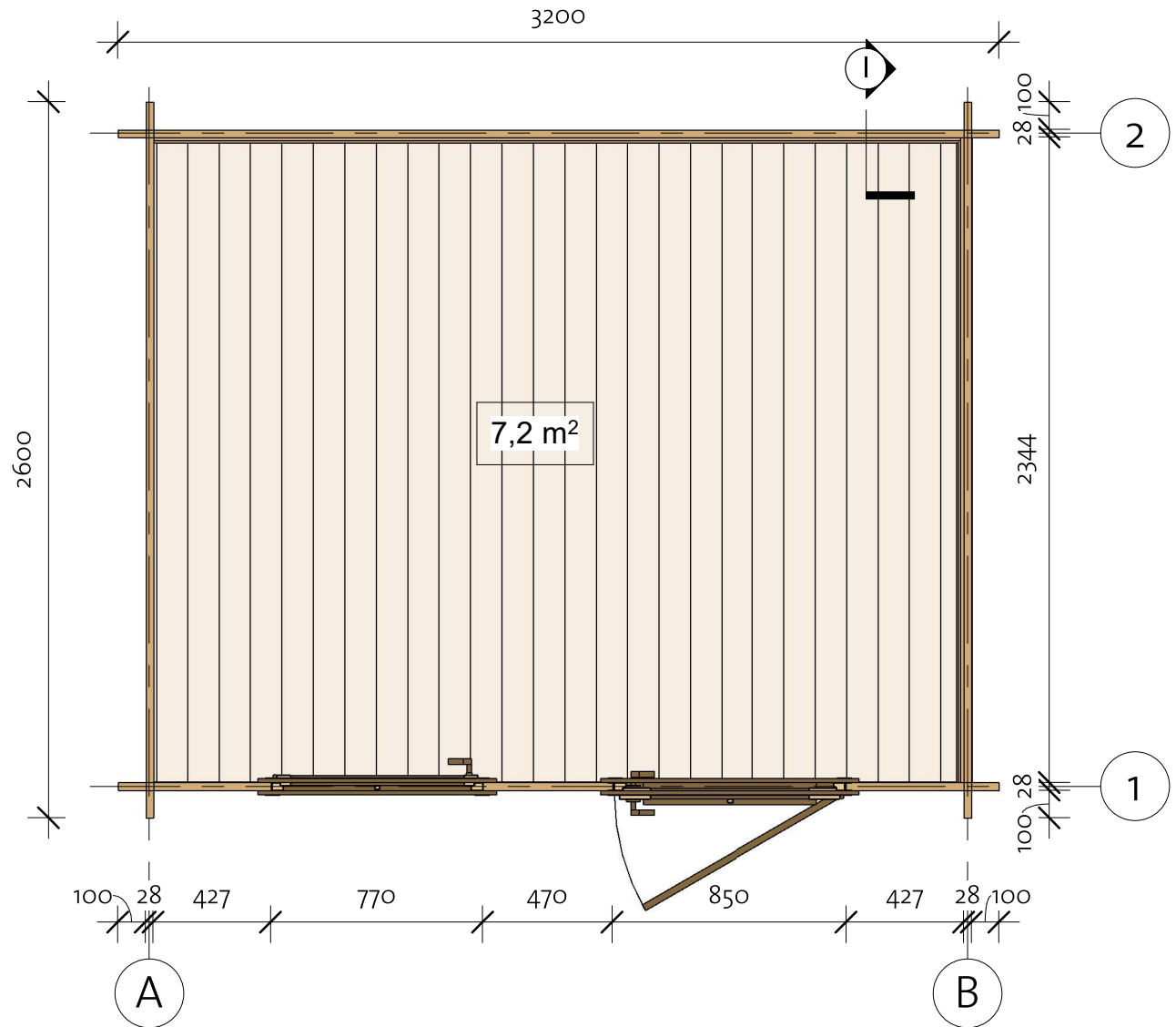

HB 3024 ET-EF 28 (3000X240)

Wall 1

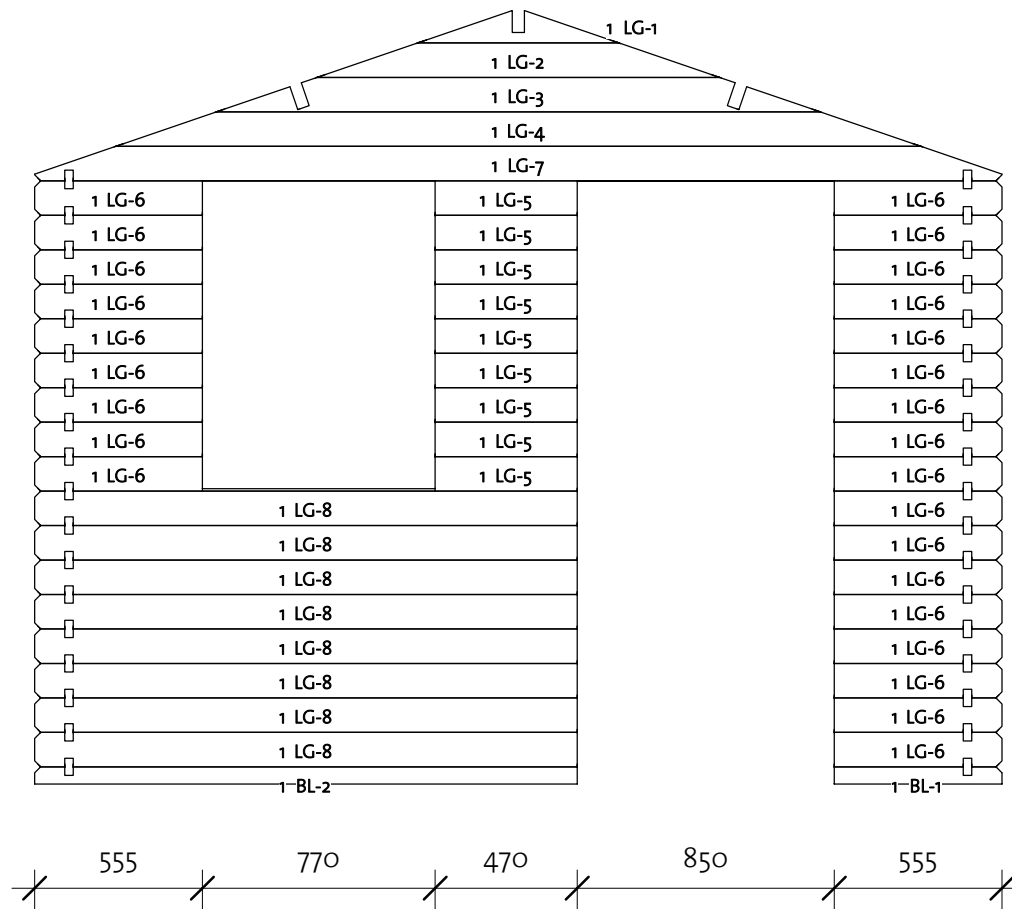



Wall 1			
Mark	Profile	Count	Cut Length

1BL-1	28x57	1	555
1BL-2	28x57	1	1795
1LG-1 *	28x114	1	666
1LG-2*	28x114	1	1332
1LG-3*	28x114	1	1998
1LG-4*	28x114	1	2664
1LG-5	28x114	9	470
1LG-6	28x114	26	555
1LG-7*	28x114	1	3200
1LG-8	28x114	8	1795

* Gable - delivered premounted

Log Profile Wall 1	
Profile	Profile

28x57	
28x114	

HB 3024 ET-EF 28 (300x240)

Wall 2



Wall 2			
Mark	Profile	Count	Cut Length

2BL-1	28x57	1	3200
2LG-1 *	28x114	1	666
2LG-2 *	28x114	1	1332
2LG-3 *	28x114	1	1998
2LG-4 *	28x114	1	2664
2LG-5	28x114	17	3200
2LG-6 *	28x114	1	3200

* Gable - delivered premounted

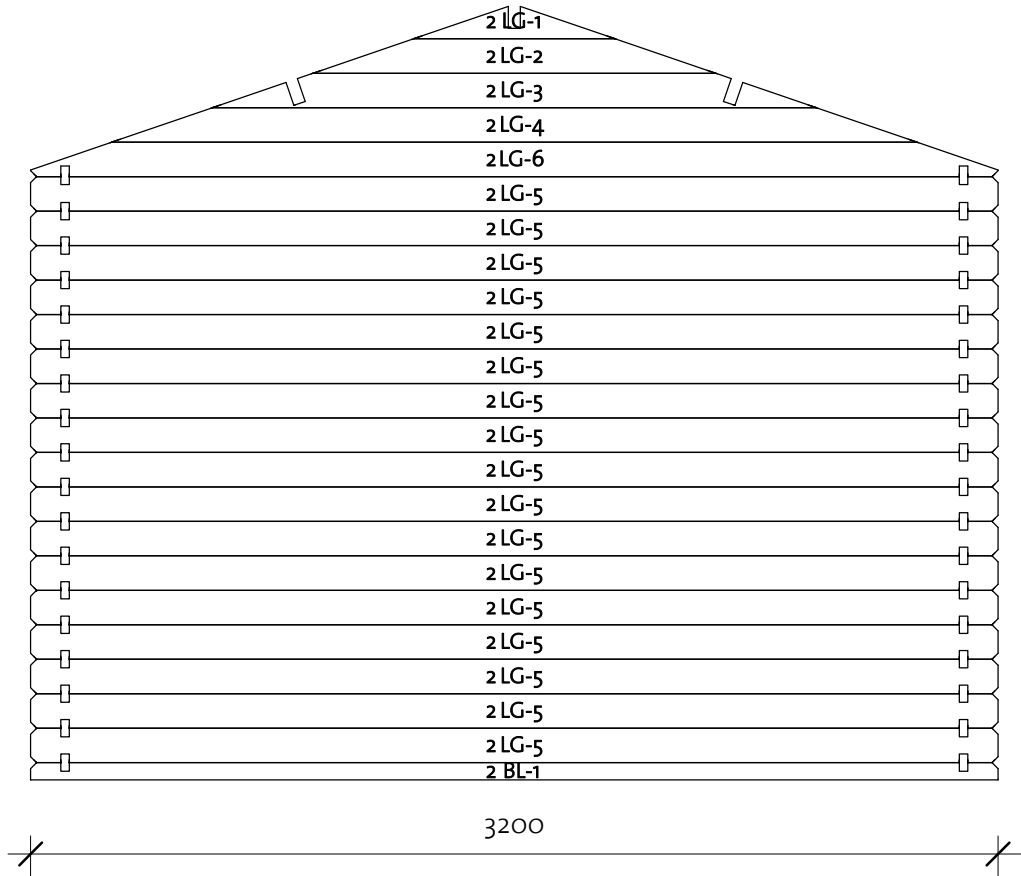

Log Profile Wall 2	
Profile	Profile

28x57	
28x114	

HB 3024 ET-EF 28 (3000x240)

Wall A

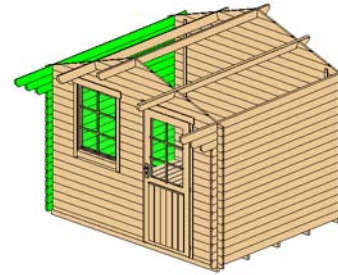

Wall A			
Mark	Profile	Count	Cut Length

ALG-1	28x114	15	2600
ALG-2	28x114	1	2800
ALG-3	28x114	1	3000
ATL-1	28x123	1	3300

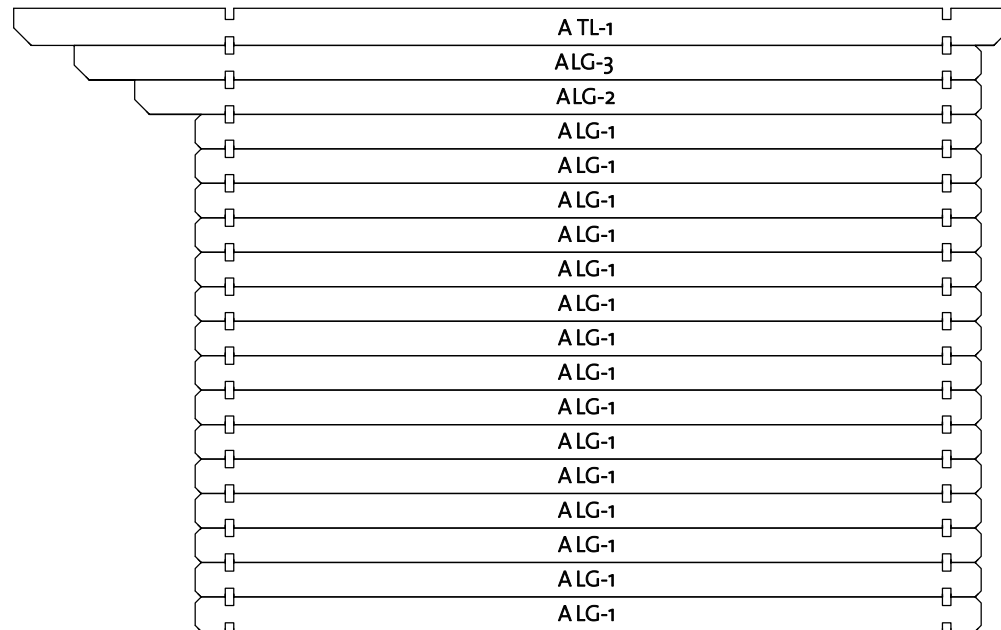

Log Profile Wall A	
Profile	Profile

28x114	
28x123	

HB 3024 ET-EF 28 (300X240)

Wall 1

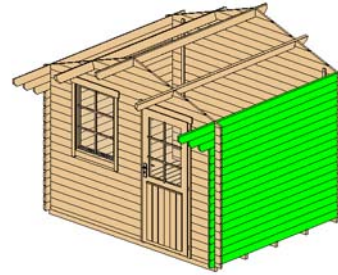

Wall B			
Mark	Profile	Count	Cut Length

BLG-1	28x114	15	2600
BLG-2	28x114	1	2800
BLG-3	28x114	1	3000
BTL-1	28x123	1	3300

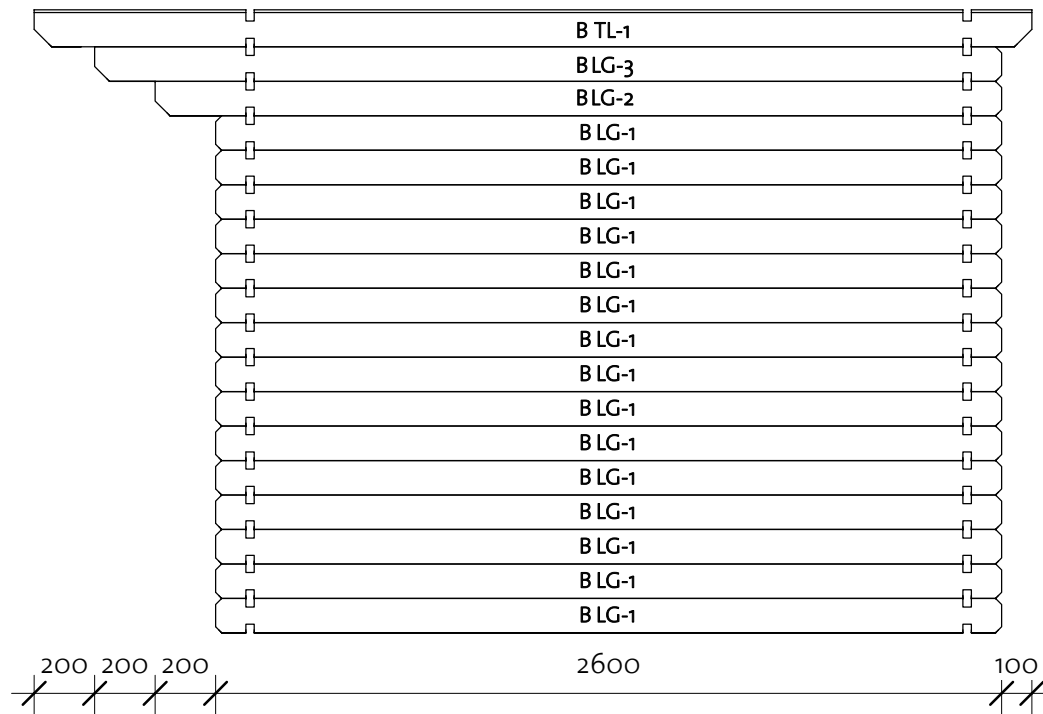





Log Profile Wall B	
Profile	Profile

28x114	
28x123	

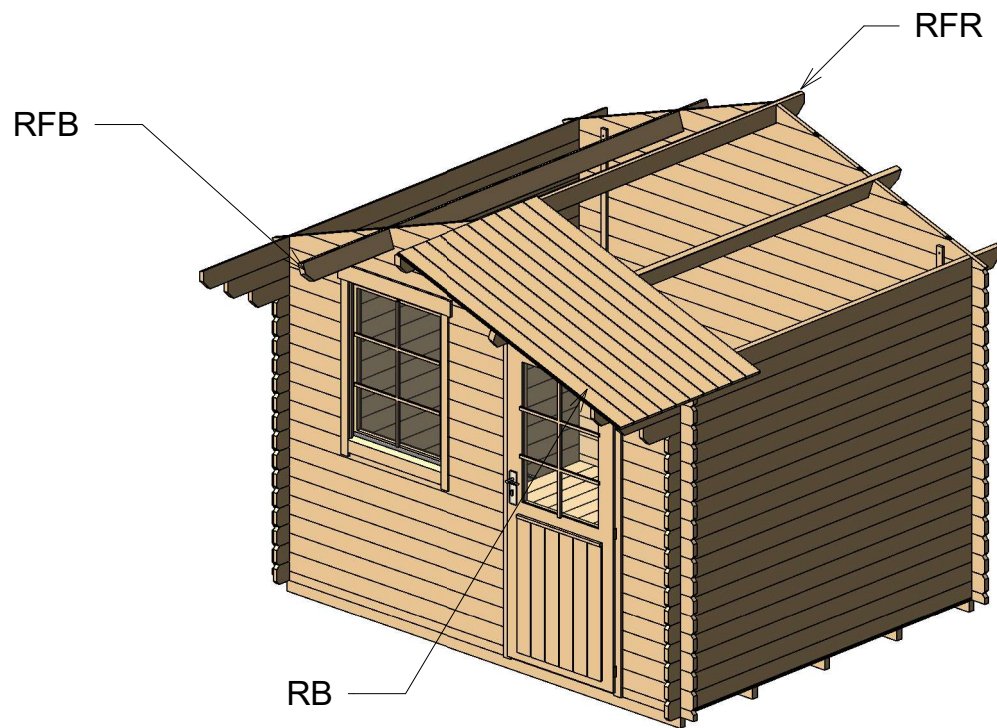
HB 3024 ET-EF 28 (300X240)

Roof 1



Roof				
Mark	Type	Profile	Count	Length
RFR	Ridge 40X120		1	3300
RFB	Beam 40X120		2	3300
RB	17X114		60	1797

HB 3024 ET-EF 28 (300X240)

Roof 2

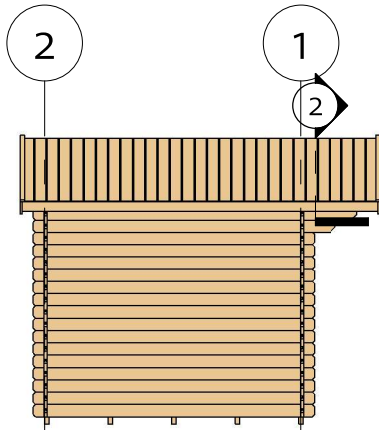

② Fascia

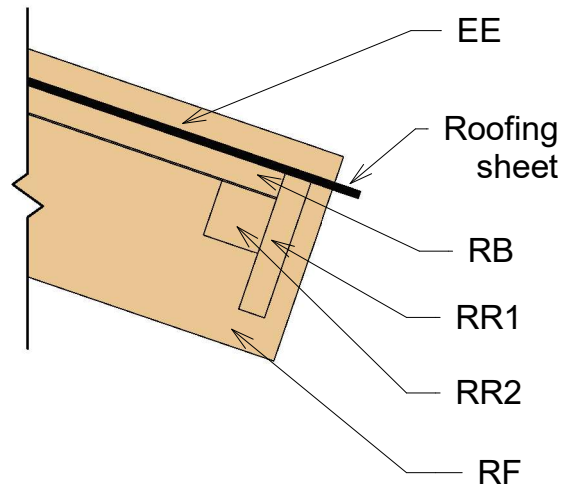

③ Roof Reinforcement

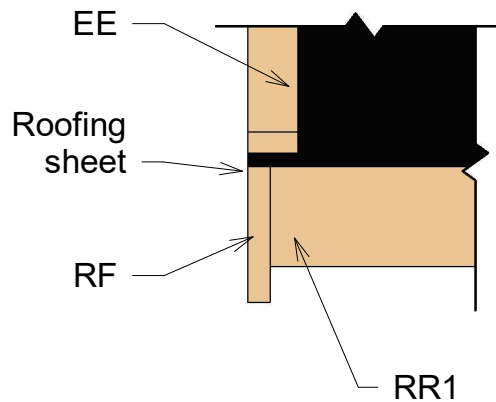
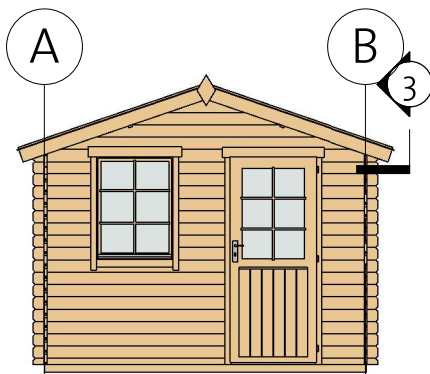

Fascia Schedule				
Mark	Type	Profile	Count	Length
EE	Eave Edging 18x40		4	1830
RF	Roof Fascia 18x120		4	1830
RR1	Roof reinforcement 18x95		2	3300
RR2	Roof reinforcement 38x38		2	3300

HB 3024 ET-EF 28 (300X240)

Extras

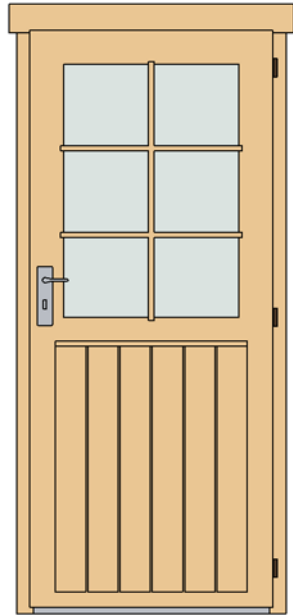

Door Schedule				
Model	Type	Width	Height	Count
BD3R	Basic door 3 right	840	1955	1
DCB6	Door Crossbar 6	--	--	1

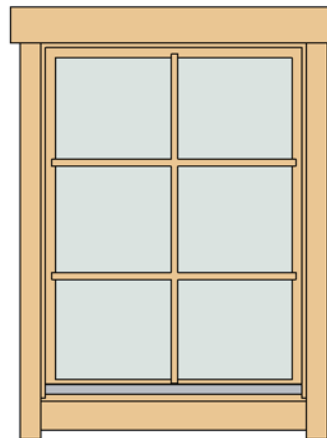

Window Schedule				
Mark	Type	Height	Width	Count
BW1R	Basic window 1 right	990	765	1
WCB6	Windows Crossbar 6	--	--	1

Fasteners/Extras		
Name	Type	Count

Hitblock	300-400 mm	
Screws	5,0 x 70	10
Bolts	M8 x 60	12
Screws	6,0 x 140	25
Nails	1,4 x 40	30
Screws	4,0 x 40	75
Screws	4,0 x 50	350

Type	Count
Romb	2

Type	Count	Length
Windboard 18x40	4	2200



HB 3024 ET-EF 28 (300X240)

List of all items 1



Impregnated foundation beams

Mark	Type	Profile	Count	Length
IFB	IFB 40x70		5	2990





Floor Schedule

Mark	Type	Profile	Count	Length
FB	FB 17x114		27	2338
BB1	BB 20x40		2	3000
BB2	BB 20x40		2	2400

Roof

Mark	Type	Profile	Count	Length
RFR	Ridge 40x120		1	3300
RFB	Beam 40x120		2	3300
RB	17x114		60	1797

Fascia Schedule

Mark	Type	Profile	Count	Length
EE	Eave Edging 18x40		4	1830
RF	Roof Fascia 18x120		4	1830
RR1	Roof reinforcement 18x95		2	3300
RR2	Roof reinforcement 38x38		2	3300

HB 3024 ET-EF 28 (300X240)

List of all items 2



Wall 1			
Mark	Profile	Count	Cut Length

1BL-1	28x57	1	555
1BL-2	28x57	1	1795
1LG-1 *	28x114	1	666
1LG-2 *	28x114	1	1332
1LG-3 *	28x114	1	1998
1LG-4 *	28x114	1	2664
1LG-5	28x114	9	470
1LG-6	28x114	26	555
1LG-7 *	28x114	1	3200
1LG-8	28x114	8	1795

Wall A			
Mark	Profile	Count	Cut Length

ALG-1	28x114	15	2600
ALG-2	28x114	1	2800
ALG-3	28x114	1	3000
ATL-1	28x123	1	3300

Log profiles	
Profile	Profile

28x57	
28x114	

Wall 2			
Mark	Profile	Count	Cut Length

2BL-1	28x57	1	3200
2LG-1 *	28x114	1	666
2LG-2 *	28x114	1	1332
2LG-3 *	28x114	1	1998
2LG-4 *	28x114	1	2664
2LG-5	28x114	17	3200
2LG-6 *	28x114	1	3200

* Gable - delivered premounted

Wall B			
Mark	Profile	Count	Cut Length

BLG-1	28x114	15	2600
BLG-2	28x114	1	2800
BLG-3	28x114	1	3000
BTL-1	28x123	1	3300

Log profiles	
Profile	Profile

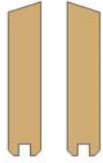
28x123	
--------	---